

H1

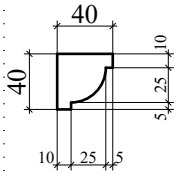

H2

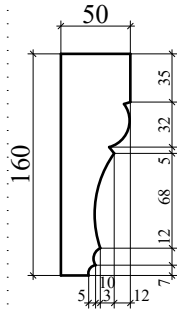

H2N

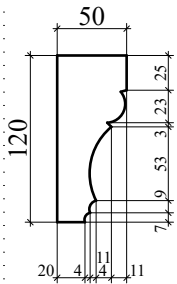

H3

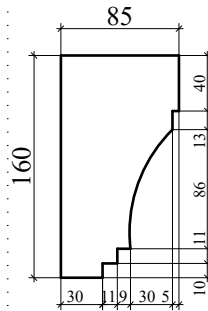

H4

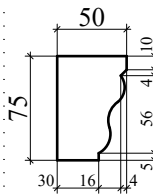

H5

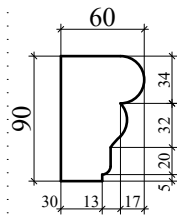

H6

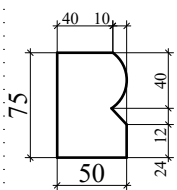

H7

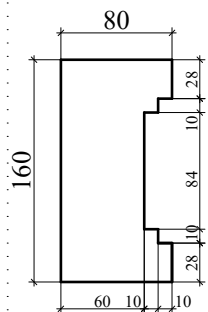

H8

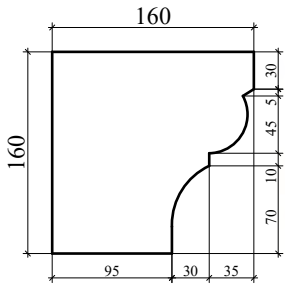

H9

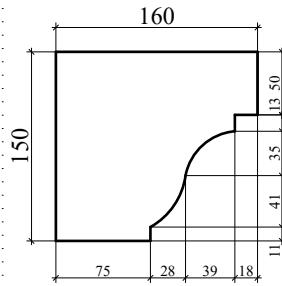

H10

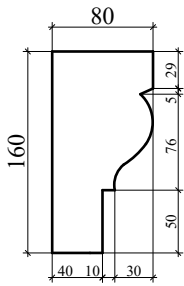

H11

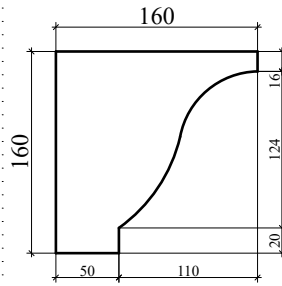

H12

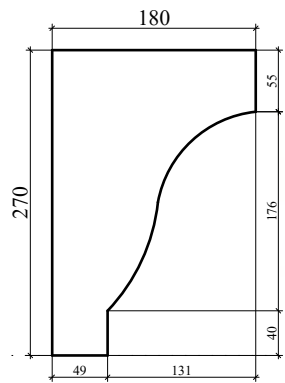

H13

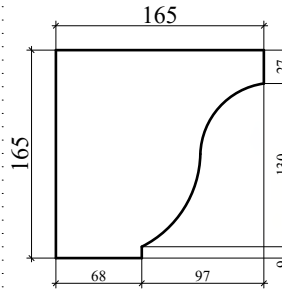

H14

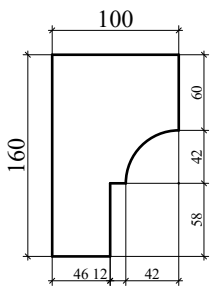

H15

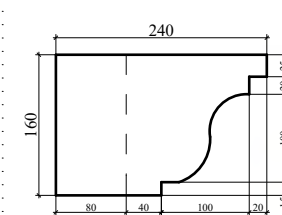

H1 6

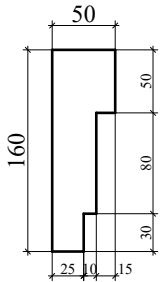

H1 7

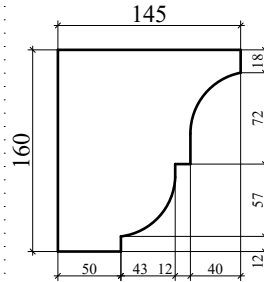

H1 8

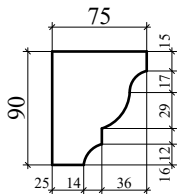

H1 9

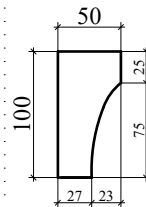

H2 0

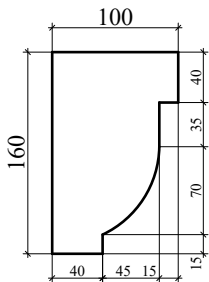

H2 1

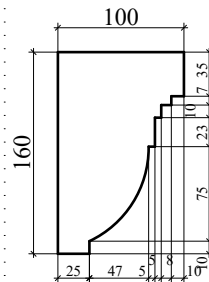

H2 2

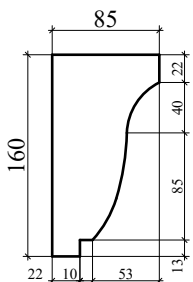

H2 3

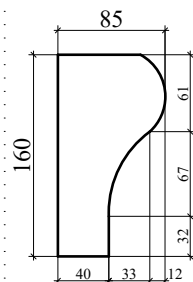

Н2.4:

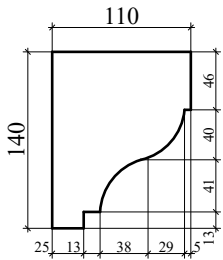

Н2.5:

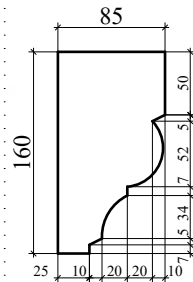

Н2.6:

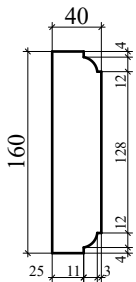

Н2.7:

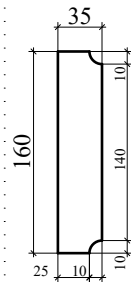

Н2.8:

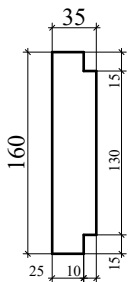

Н2.9:

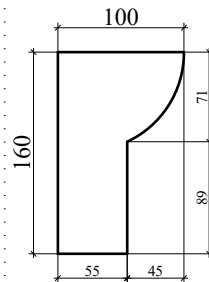

Н3.0:

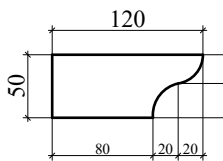

Н3.1:

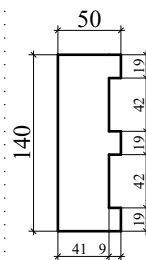

НЗ 2:

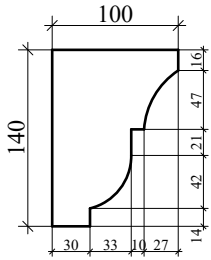

НЗ 3:

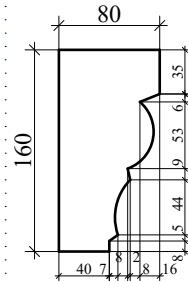

НЗ 4:

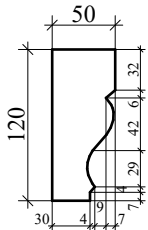

НЗ 5:

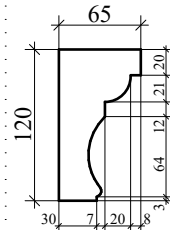

НЗ 6:

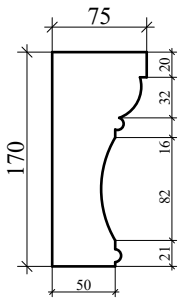

НЗ 7:

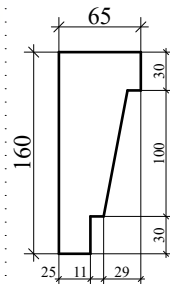

НЗ 8:

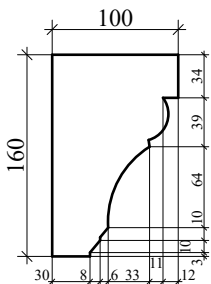

НЗ 9:

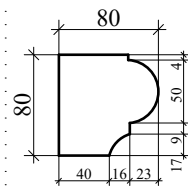

H4.0

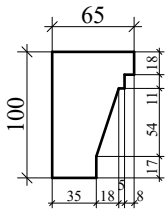

H4.1

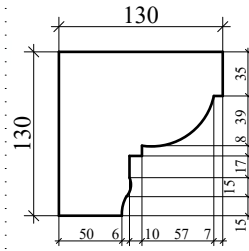

H4.2

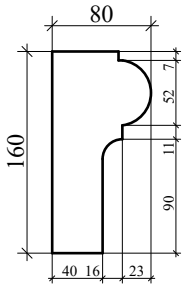

H4.3

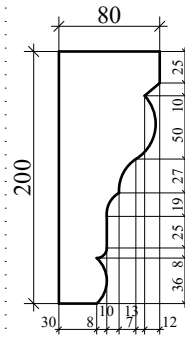

H4.4

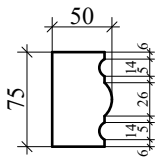

H4.5

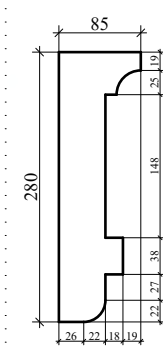

H4.6

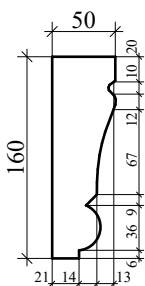

H4.7

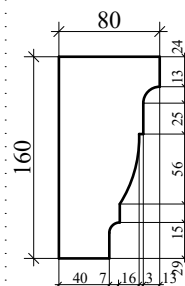

H4 8

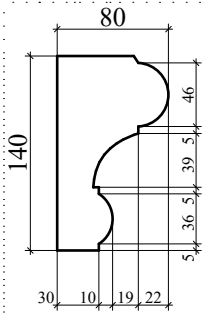

H4 9

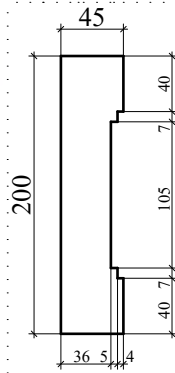

H5 0

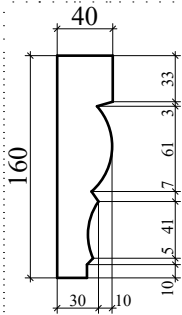

H5 1

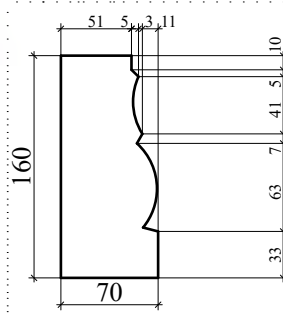

H5 2

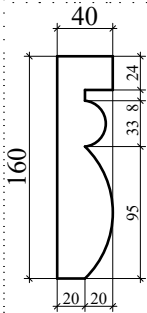

H5 3

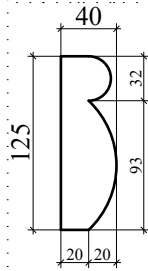

H5 4

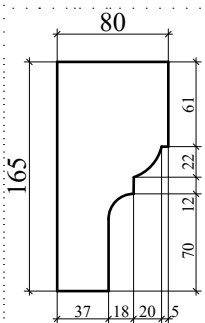

H5 5

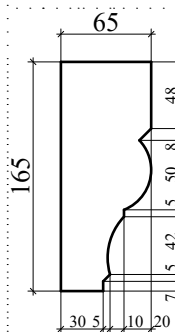

Размеры сырья

Кубик

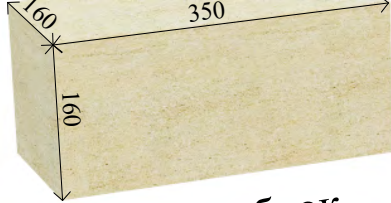

Карандаш



Маленький блок

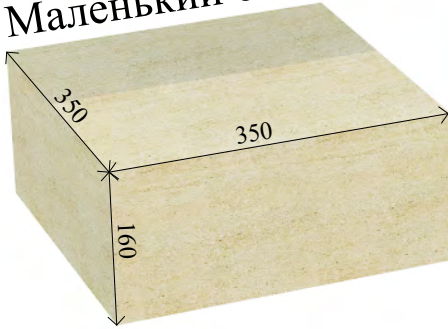

Большой блок



Форматы

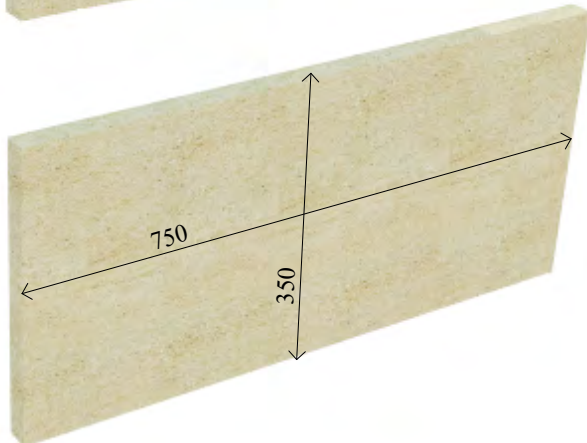
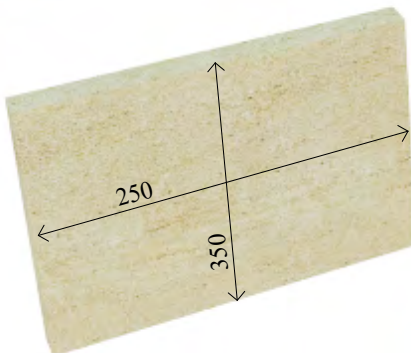
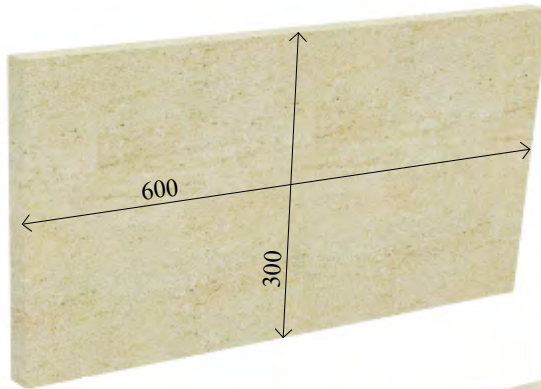
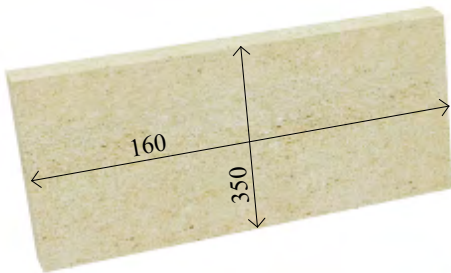

Фаска А по 4м сторонам

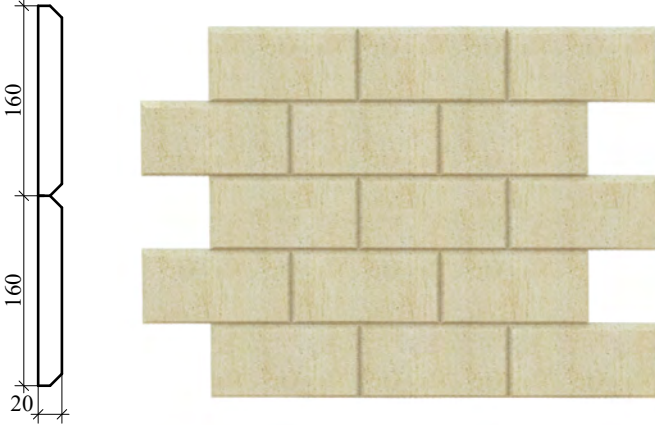

Плитка с фаской В по 4м сторонам



Плитка без фаски со вставкой

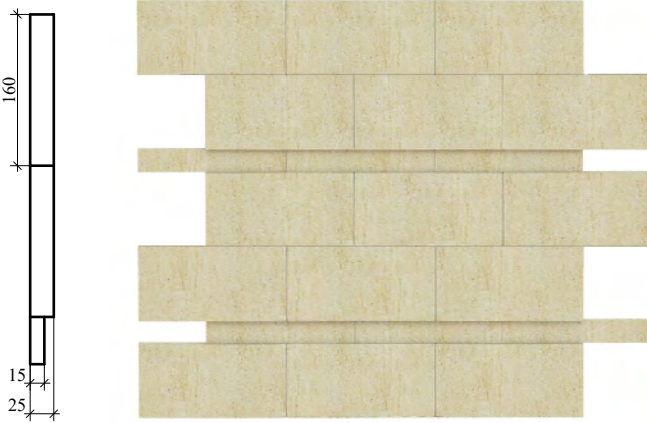

Плитка с фаской D по 2 длинным сторонам

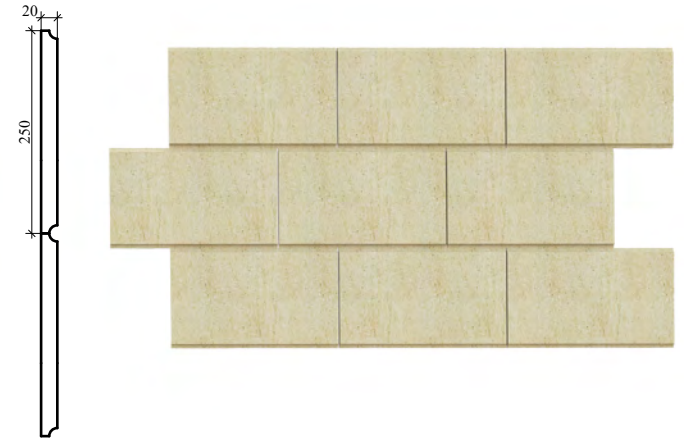

Плитка с фаской D по 2м длинным сторонам со вставкой

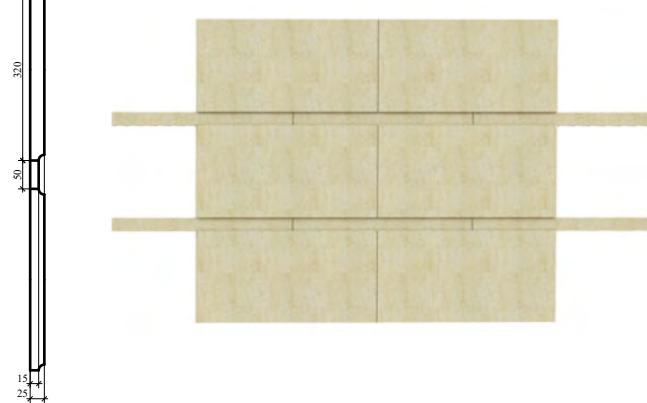

Плитка без фаски со вставкой

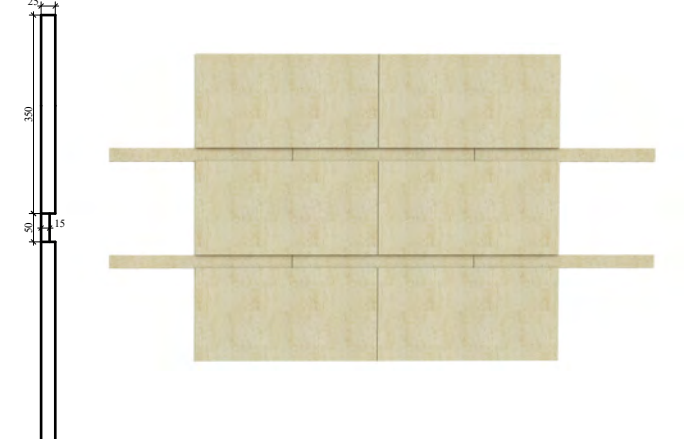

Плитка с фаской В по одной длинной стороне

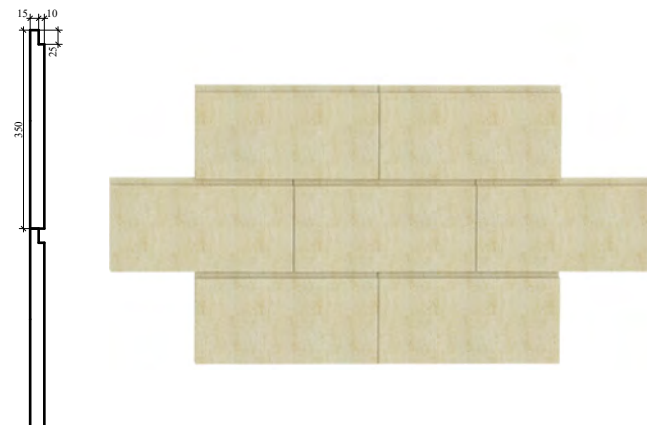

Плитка с фаской А по двум длинным сторонам

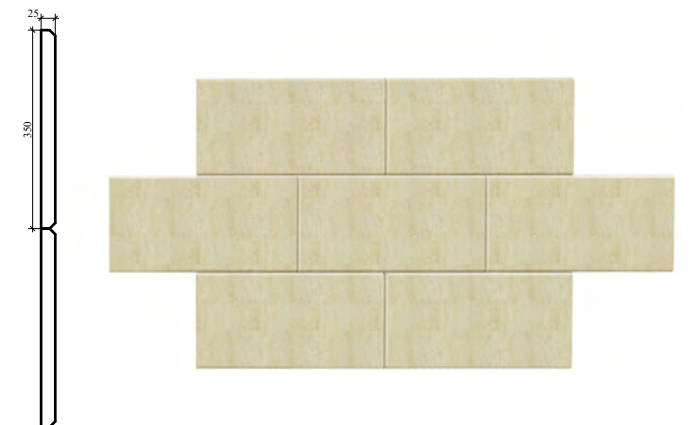

Kn-01

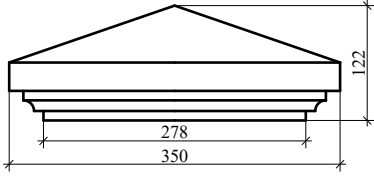

Kn-02

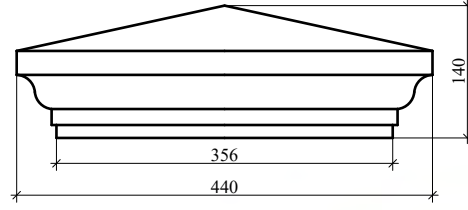

Kn-03

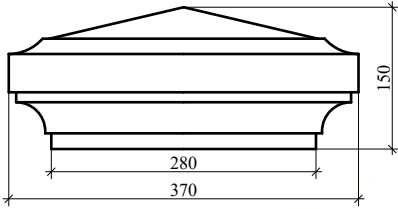

Kn-04

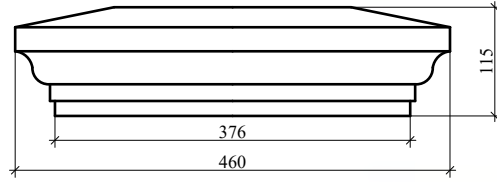

Kn-05

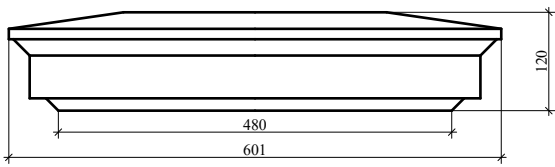

Kn-06

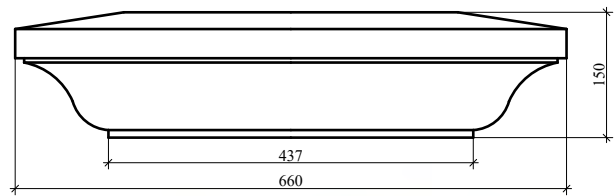

Kn-07

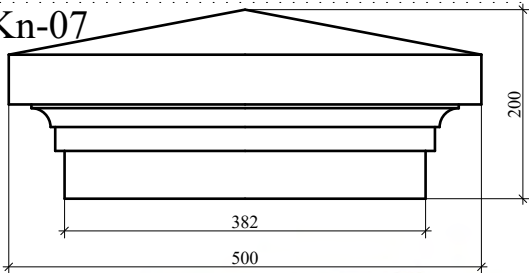

Kn-08

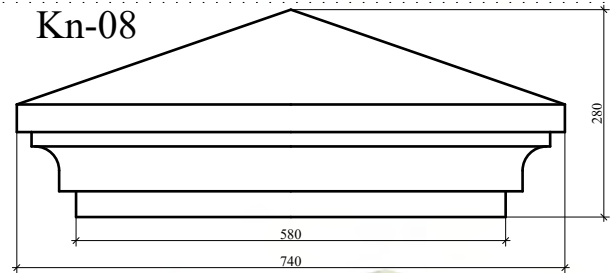



КДМ

ФАСАДЫ ИЗ КАМНЯ

WWW.KDMASTERA.RU +7(495)704-60-38

Кн-09

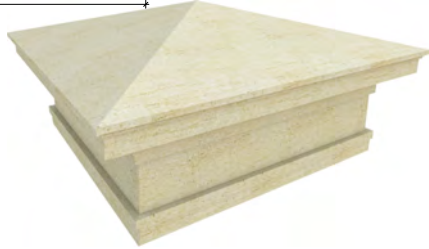
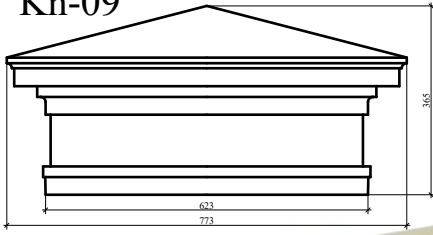

Кн-10

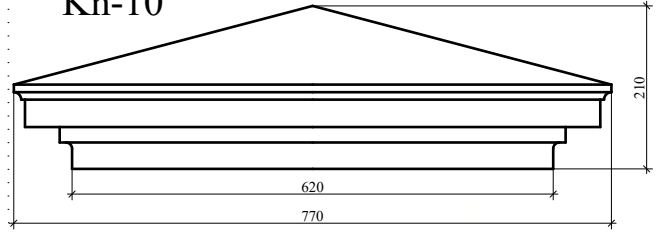

Кн-11

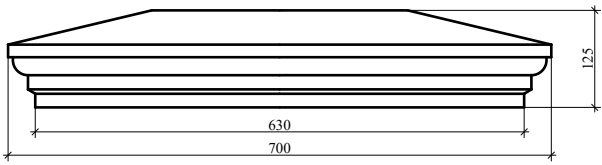

Рк-01

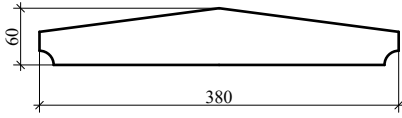

Рк-02

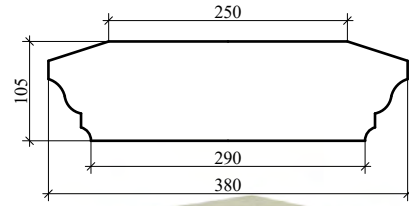

Рк-03

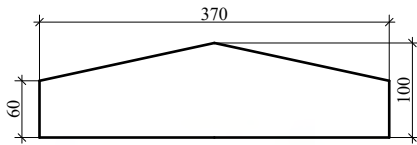

Рк-04

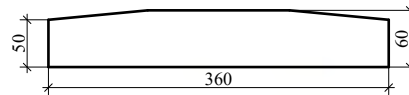

Рк-05

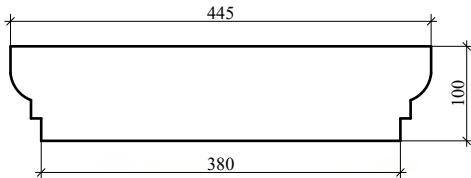

Рк-06

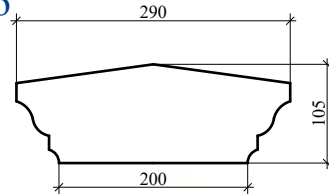

Рк-07

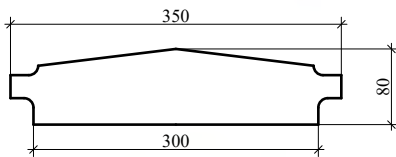

Рк-08

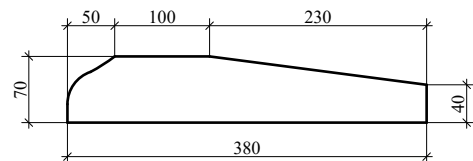

Рк-09

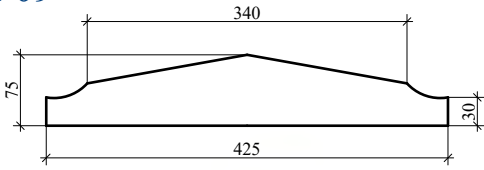

Рк-10

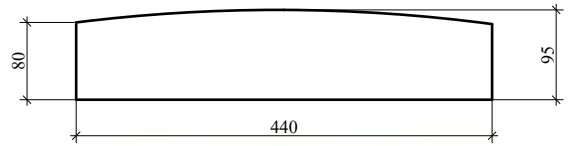

Рк-11

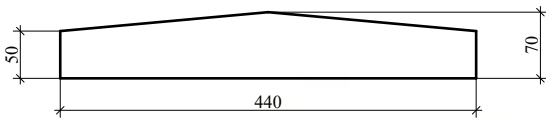

Рк-12

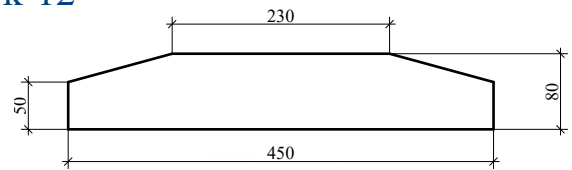

Рк-13

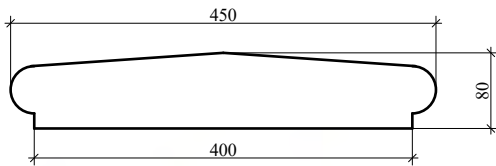

Рк-14

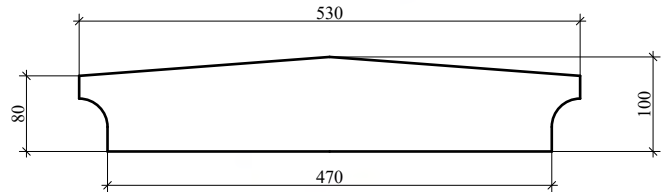

Рк-15

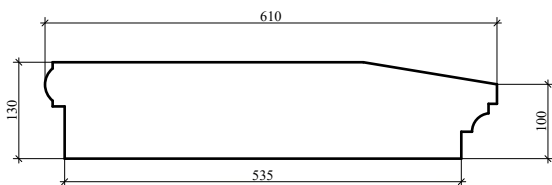

Рк-16

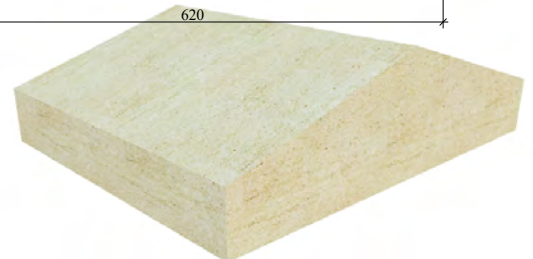
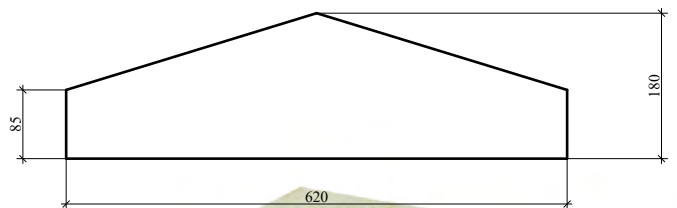



КДМ

ФАСАДЫ ИЗ КАМНЯ

WWW.KDMASTERA.RU +7(495)704-60-38

Рк-17

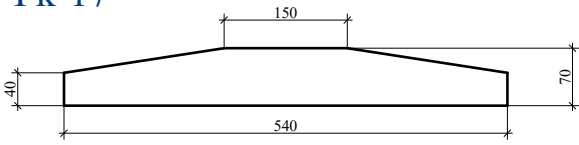

Рк-18

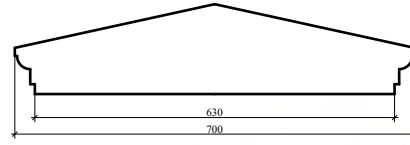

Рк-19

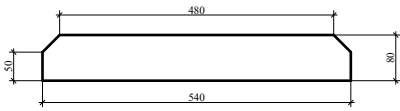

Рк-20

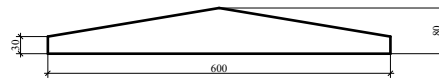

Pb-01

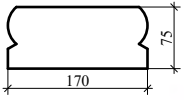

Pb-02

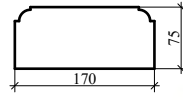

Pb-03

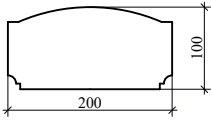

Ob-01

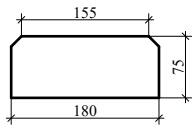

Ob-02

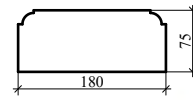

Ob-03

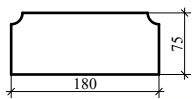

Ob-04

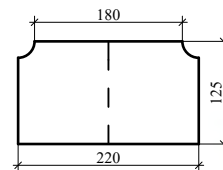

Тб-01

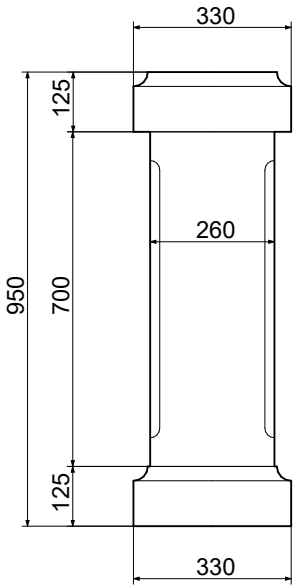

Тб-02

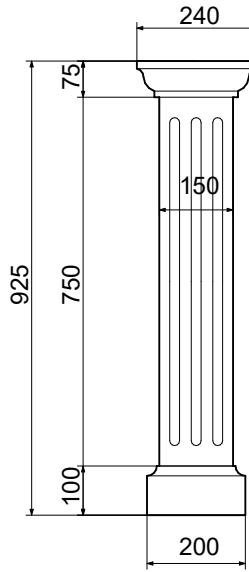

Тб-03

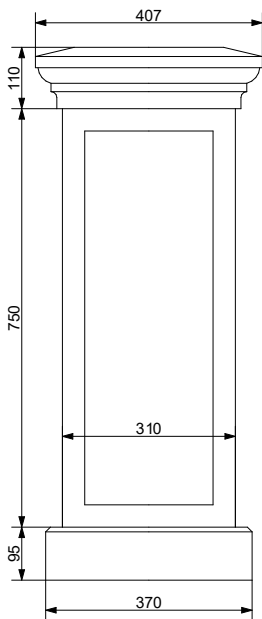

Тб-04

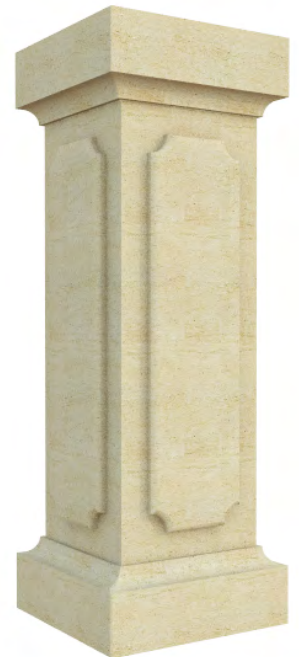
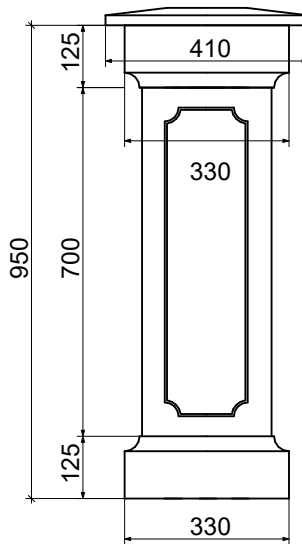

Тб-05

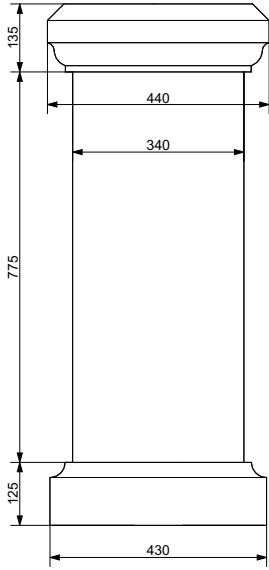

Тб-06

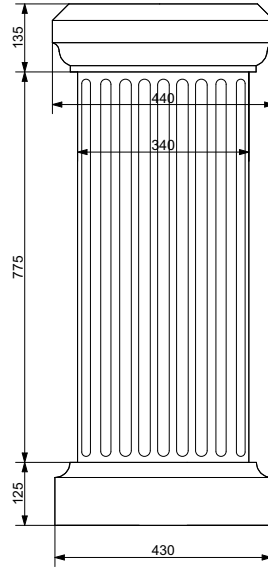

В1-01

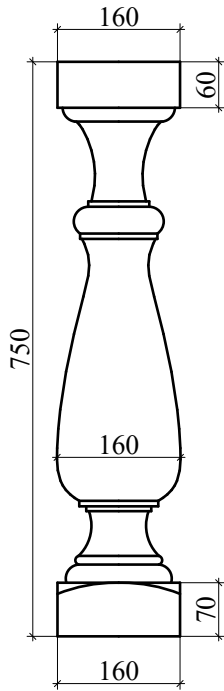

В1-02

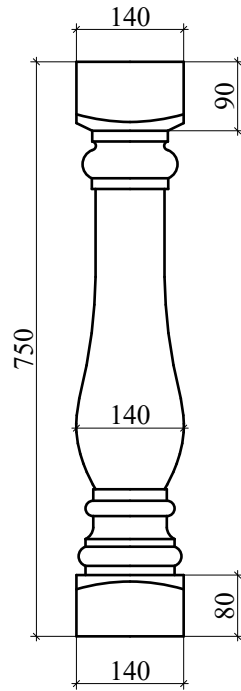

В1-03

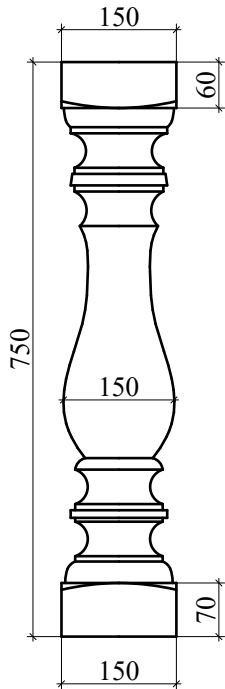

В1-04

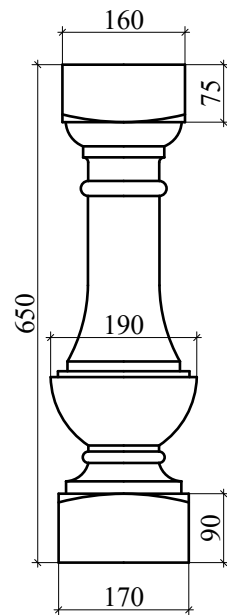

В1-04

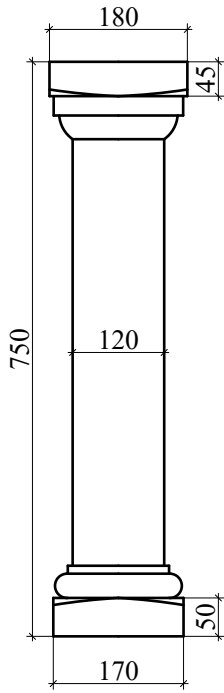

В1-05

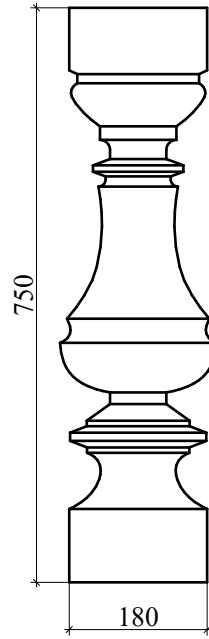

В1-06

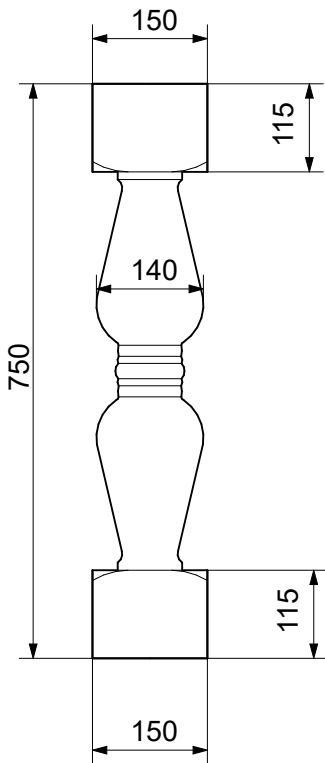

В1-07

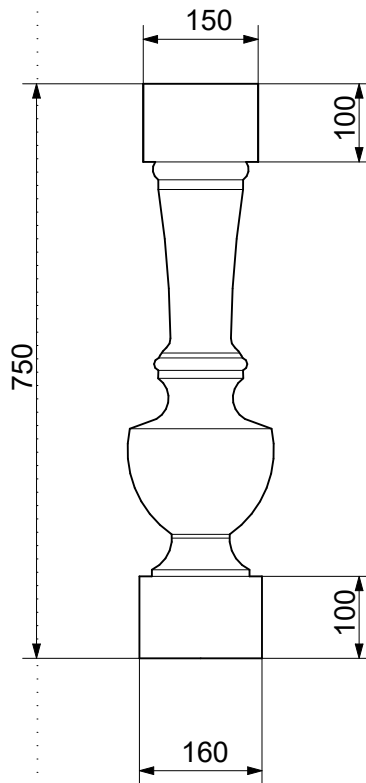

Dsh-01

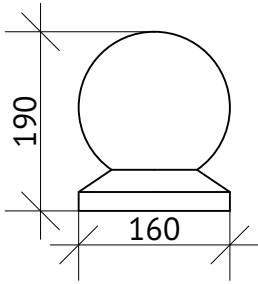

Dsh-02

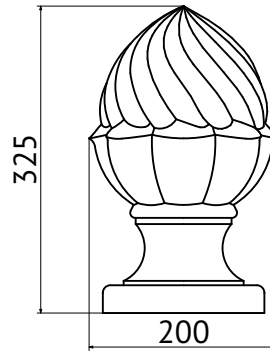

Dsh-03

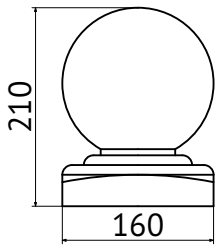

Dsh-04

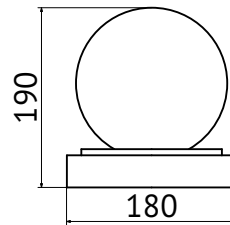

Dsh-05

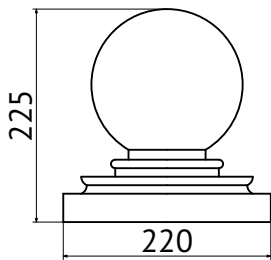

Dsh-06

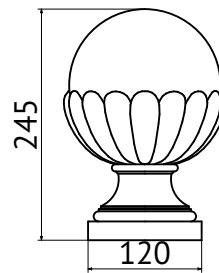

Dsh-07

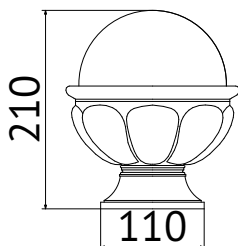

Dsh-08

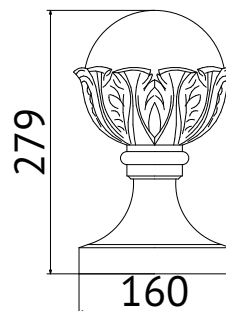

Kh-01

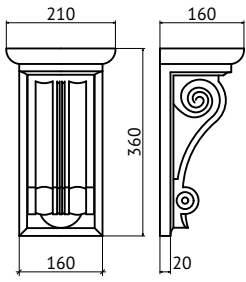

Kh-02

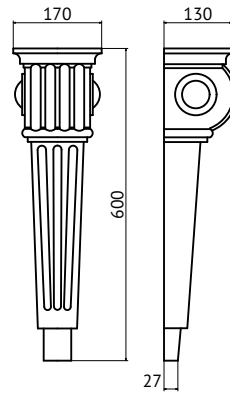

Kh-03

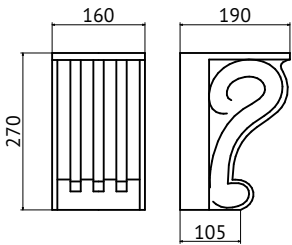

Kh-04

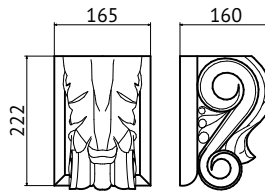

Kh-05

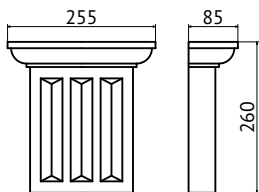

Kh-06

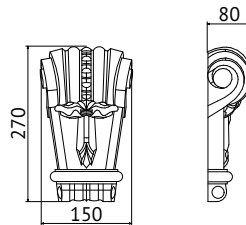

Kh-07

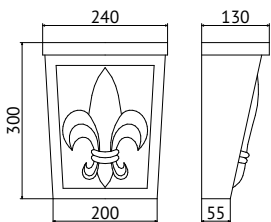

Kh-08

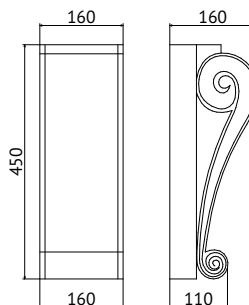

Kh-09

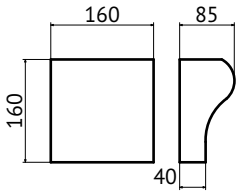

Kh-10

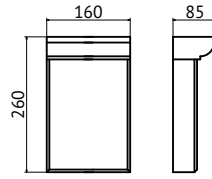

Kh-11

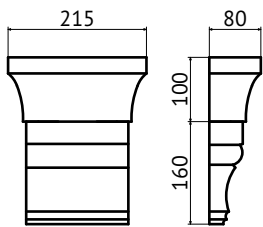

Kh-12

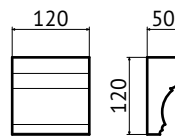

Kh-13

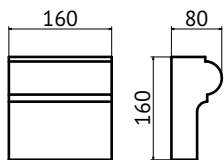

Kh-14

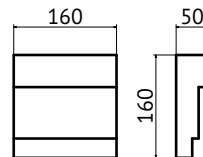

P-01

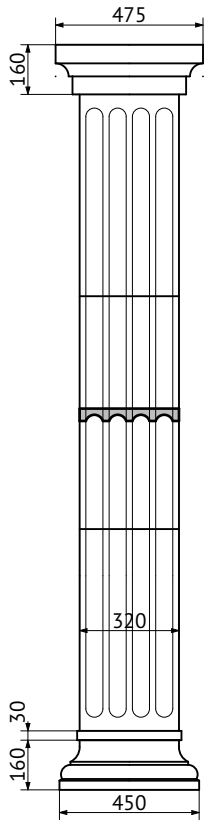

P-02

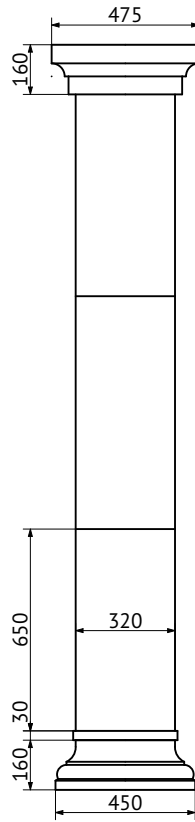

P-03

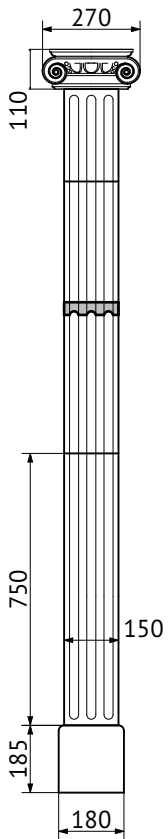

P-04

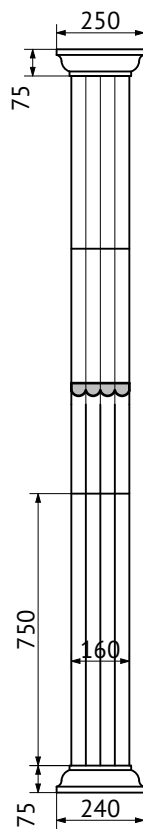

P-05

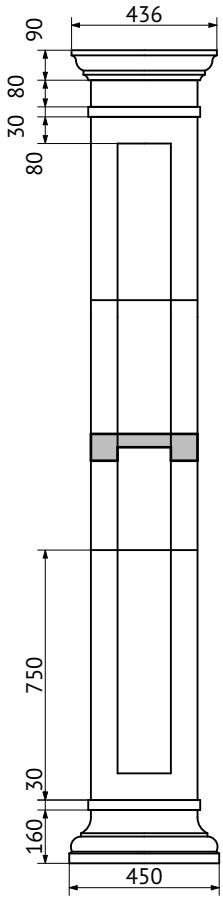

P-06

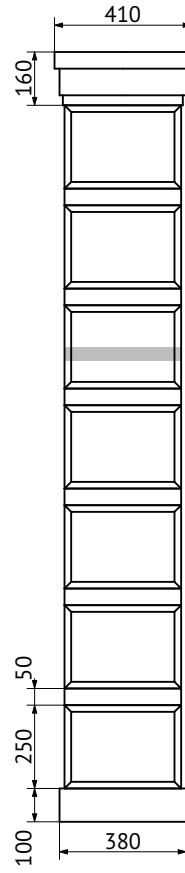

P-07

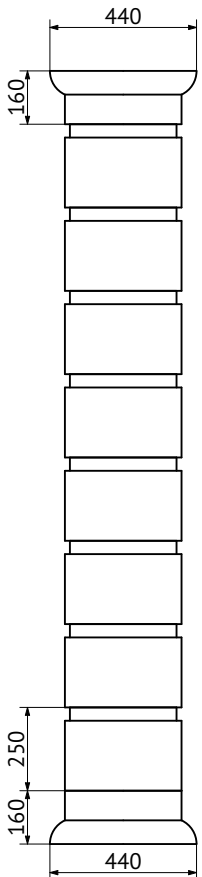

P-08

Zk-01

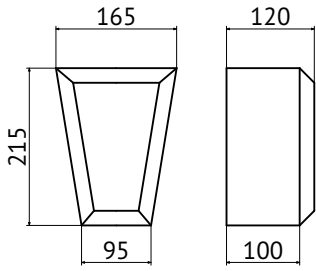

Zk-02

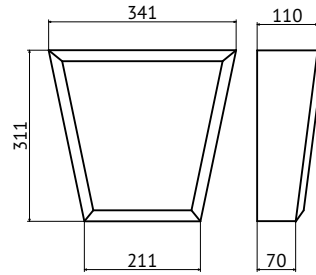

Zk-03

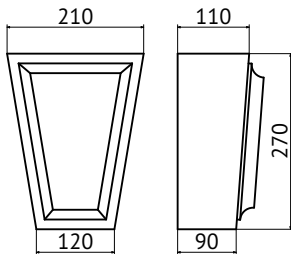

Zk-04

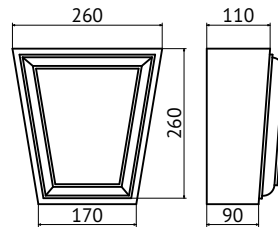

Zk-05

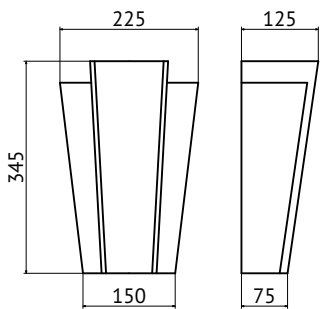

Zk-06

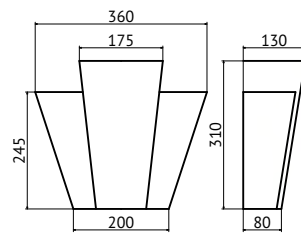

Zk-07

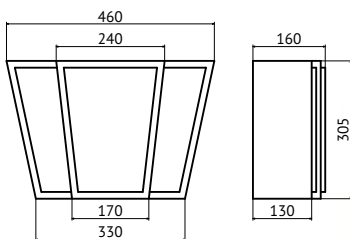

Zk-08

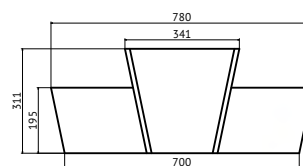

Zk-09

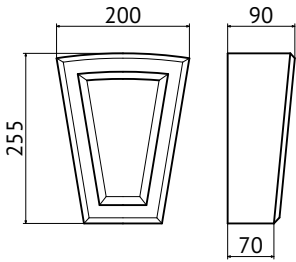

Zk-10

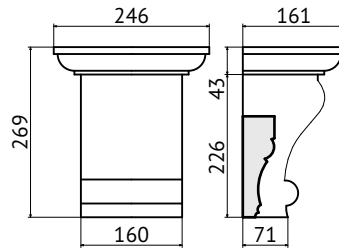

Zk-11

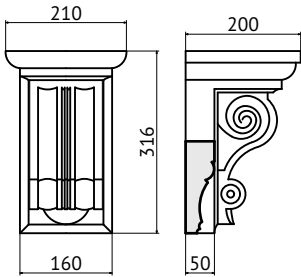

Zk-12

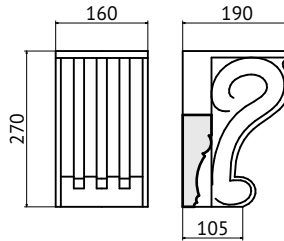

Zk-13

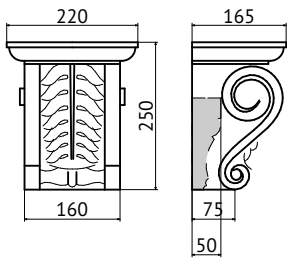

Kn-01

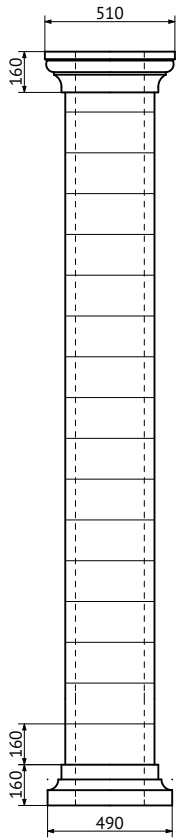

Kn-02

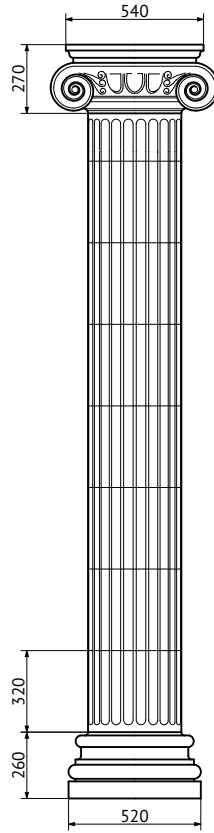

Kn-03

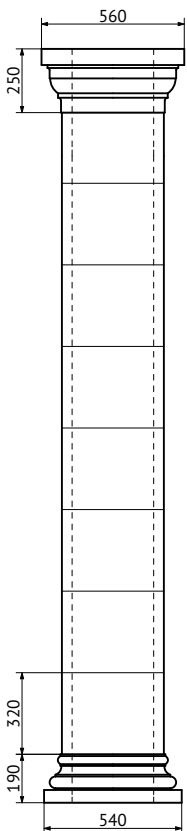

Kn-04

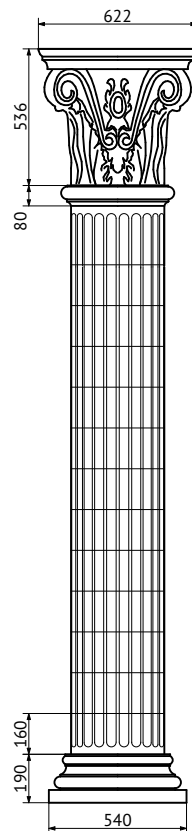

Kn-05

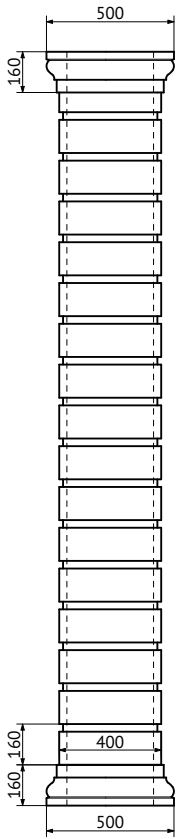

Kn-06

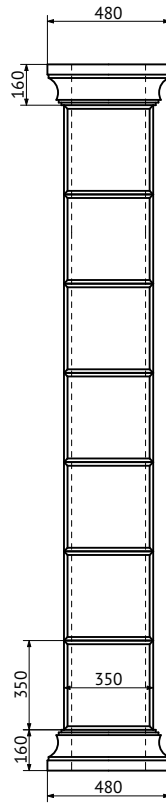

Kn-07

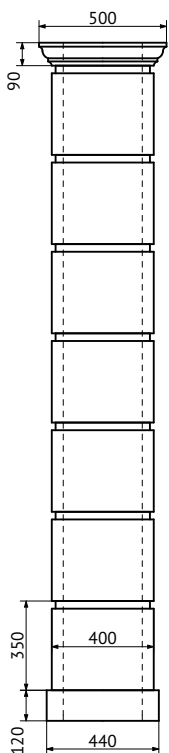

Kn-08

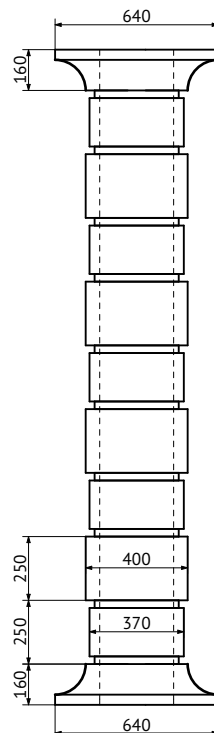

Kn-09

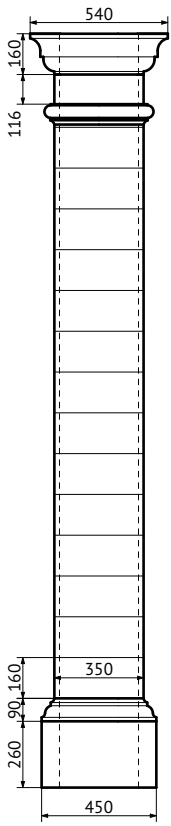



КДМ

ФАСАДЫ ИЗ КАМНЯ

WWW.KDMASTERA.RU +7(495)704-60-38

R-01
35x160x330/160
без фаски

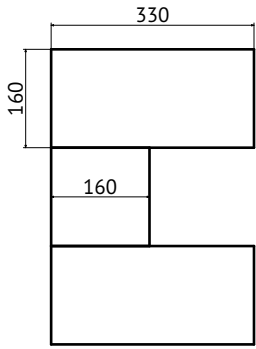

R-02
35x160x330/160
без фаски

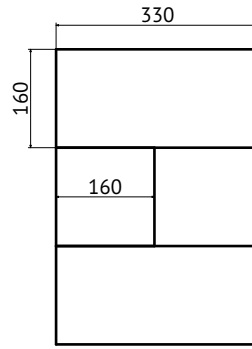

R-03
40x160x330
с фаской В

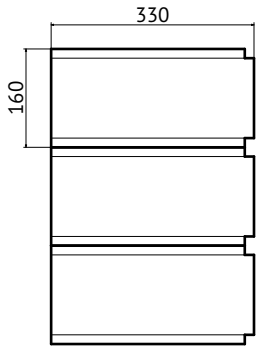

R-04
40x160x330
с фаской С

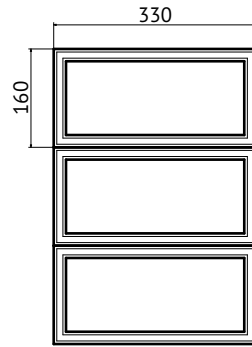

R-05
40x250x320/400
с фаской С

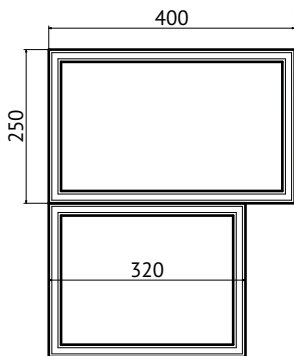

R-06
40x160x330/160
с фаской С

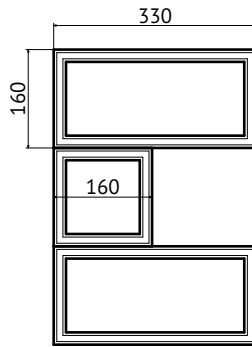

R-07
40x160x330/160
с фаской А

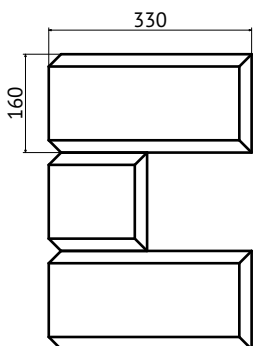

R-08
50x330x750
с фаской А

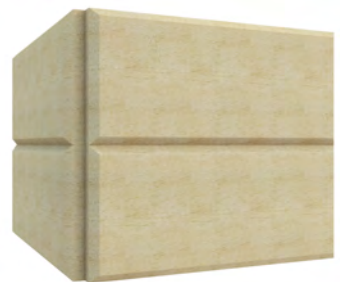
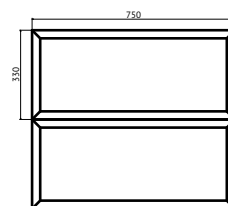



КДМ

ФАСАДЫ ИЗ КАМНЯ

WWW.KDMASTERA.RU +7(495)704-60-38

R-09
40x330x330
с фаской D

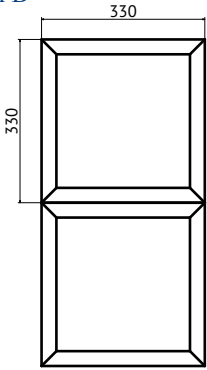

R-10
40x250x350/500
с фаской C
20x50x350
без фаски

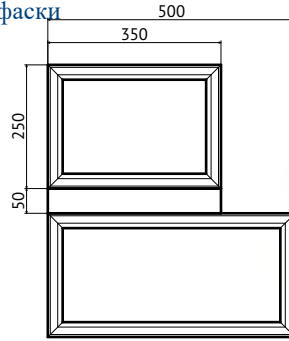

R-11
40x160x400
с фаской A

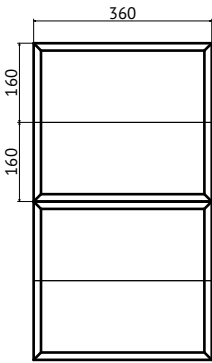

R-12
40x350x350
без фаски

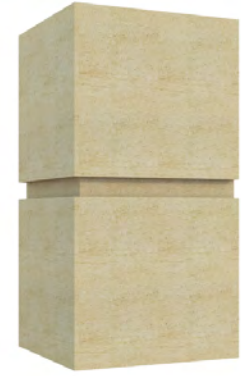
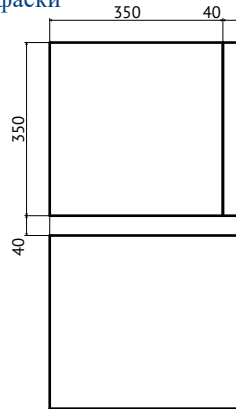

R-13
40x350/160x350
с фаской D

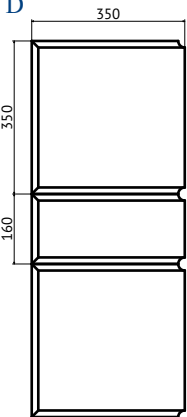

R-14
40x250x360 с фаской A
40x160x250 с фаской A

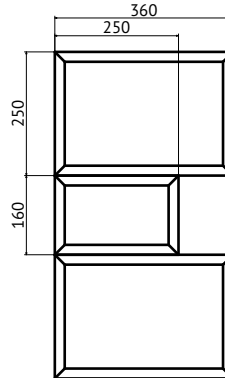

R-15
40x160x350
с фаской B
20x80x350
без фаски

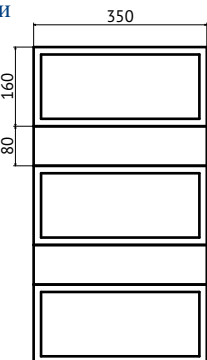

R-16
40x160x160/320
с фаской C

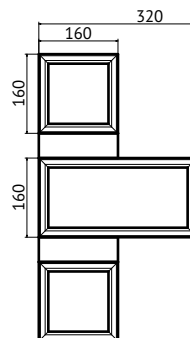



КДМ

ФАСАДЫ ИЗ КАМНЯ

WWW.KDMASTERA.RU +7(495)704-60-38

R-17
50x350x750
с фаской В

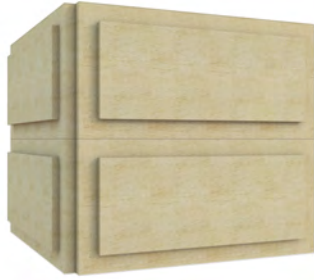
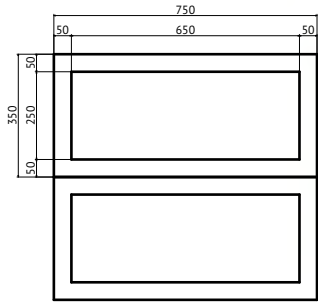

R-18
40x250x350
с фаской А

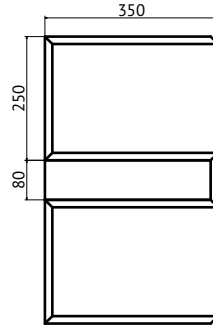

R-19
30x160x350
с фаской В

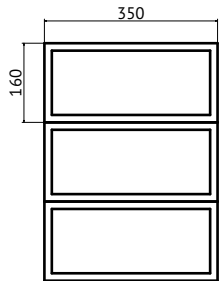

Sk-01

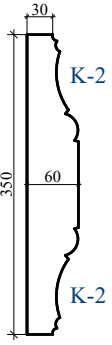

Sk-02

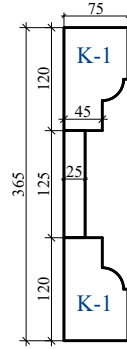

Sk-03

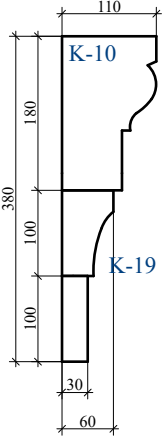

Sk-04

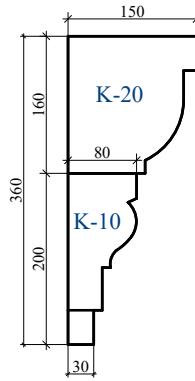

Sk-05

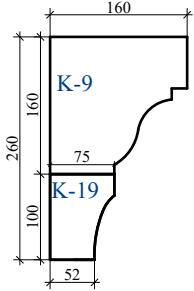

Sk-06

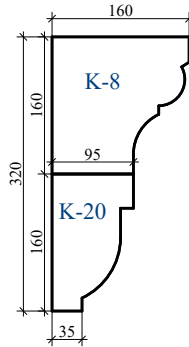

Sk-07

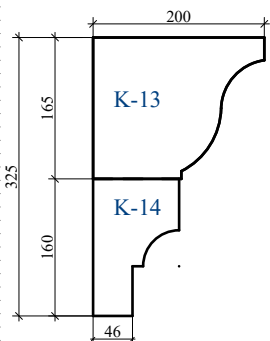

Sk-08

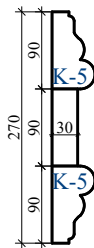

Sk-09

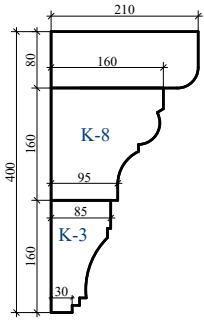

Sk-10

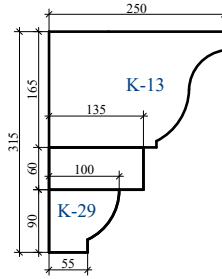

Sk-11

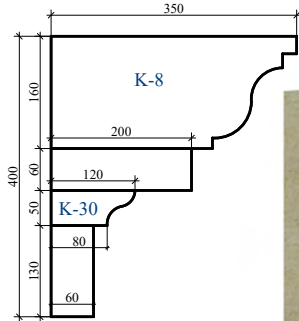

Sk-12

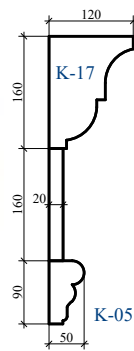

Sk-13

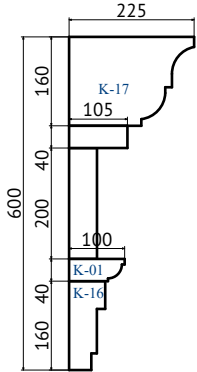

Sk-14

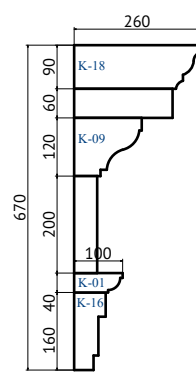

Sk-15

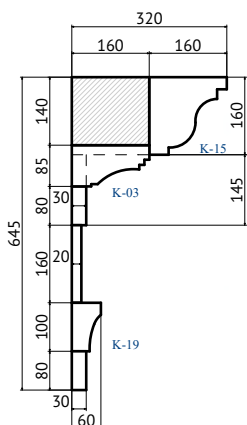

Sk-16

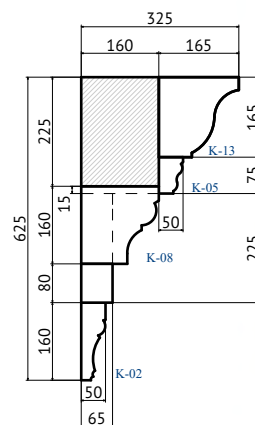



КДМ

ФАСАДЫ ИЗ КАМНЯ

WWW.KDMASTERA.RU +7(495)704-60-38

Ok-1

Наличник К-02
Подок. камень - К-02
Замк. камень - ZK-03



Ok-2

Наличник К-02
Подок. камень - К-10



Ok-3

Наличник К-02
Подок. камень - К-10
Сандрик - К-10



Ok-4

Наличник К-16



Ok-5

Наличник К-02
Подок. камень - К-10
Отлив - песчаник 30мм



Ok-6

Наличник К-02
Подок. камень - К-10
Отлив - гранит 30мм





КДМ

ФАСАДЫ ИЗ КАМНЯ

WWW.KDMASTERA.RU +7(495)704-60-38

Ok-7

Наличник К-26



Ok-8

Наличник К-26
Замк. камень ZK-03



Ok-9

Наличник К-02
Подок. камень - К-03
Вставки - К-03



Ok-10

Наличник К-02
Подок. камень - К-03
Вставки - К-03
Замковый камень -
Кронштейны -



Ok-11

Наличник К-02
Подок. камень - К-03
Замковый камень -
Кронштейны -



Ok-12

Наличник К-02
Подок. камень - К-10
Вставка - К-01





КДМ

ФАСАДЫ ИЗ КАМНЯ

WWW.KDMASTERA.RU +7(495)704-60-38

Ok-13

Наличник К-2N
Сандрик К-06
Подок. камень К-2



Ok-14

Наличник К-2
Сандрик1 К-4
Сандрик2 К-33
Кронштейн К-23
Подок. камень К-2



Ok-15

Наличник К-7
Сандрик К-18
Подок. камень К-6
Тумба К-49
Декор



Ok-16

Наличник К-36
Сандрик К-26
Кронштейн1 К-26
Кронштейн2 К-18
Подок. камень К-18
Подок. рамка К-2





КДМ

ФАСАДЫ ИЗ КАМНЯ

WWW.KDMASTERA.RU +7(495)704-60-38

Ok-19

Наличник К-2
Сандрик К-14
Подок. камень К-42
Кронштейн К-23



Ok-20

Наличник К-31
Сандрик К-41
Подок. камень К-2
Отлив из ПДА



Ok-21

Наличник К-31
Сандрик К-47
Подок. камень К-47
Замк. камень ZK-03
Кронштейн
Рамка К-44
Декор



Ok-22

Наличник К-31
Сандрик К-47
Подок. камень К-47
Замк. камень ZK-03
Кронштейн
Рамка К-44
Декор





КДМ

ФАСАДЫ ИЗ КАМНЯ

WWW.KDMASTERA.RU +7(495)704-60-38

Ok-23

Наличник К-31
Сандрик К-47
Подок. камень К-47
Кронштейн
Рамка К-44



Ok-24

Наличник К-47
Сандрик К-08
Рамка К-39
Замковый камень





КДМ

ФАСАДЫ ИЗ КАМНЯ

WWW.KDMASTERA.RU +7(495)704-60-38

Ok-25

Наличник К-16
Подок. камень брус
Кронштейн К-42
Рамка К-1
Замковый камень ZK



Ok-26

Наличник К-26



Ok-27

Наличник плитка 40x160+20x60
Сандрик К-20
Подок. камень К-14



Ok-28

Наличник К-31
Сандрик К-26





КДМ

ФАСАДЫ ИЗ КАМНЯ

WWW.KDMASTERA.RU +7(495)704-60-38

Ok-29

Наличник 35x160x160
с фаской В
Проставка 20x80x160
Подок. камень К-18
Сандрик К-18



Ok-30

Наличник К-2
Подок. камень К-18
Сандрик К-18
Кронштейн К-23



Ok-31

Наличник К-2
Брус 80x160x160
Подок. камень К-42
Замковый камень ZK



Ok-32

Наличник К-18
Добор 40x80 с фаской А
Подок. камень К-18
Замковый камень ZK
Рамка 20x80 с фаской В



Ok-33

Наличник К-18
Добор 40x80 с фаской А
Подок. камень К-24





КДМ

ФАСАДЫ ИЗ КАМНЯ

WWW.KDMASTERA.RU +7(495)704-60-38

Ok-34

Сандрик К-18
Проставка 25x100xL
Наличник К-32
Подок. камень К-32



Ok-35

Сандрик1 К-17
Проставка 25x100xL
Сандрик2 К-5
Наличник1 К-26
Наличник2 20x80xL
Подок. камень К-5



Ok-36

Наличник К-16
Подок. камень
80x60xL
60x100xL
Рамка К-16



Ok-37

Наличник К-7
Подок. камень К-10
Мозаика 20/40x160x160



Ok-38

Наличник 30x250x250
с фаской А
Проставка 15x80x250
Сандрик К-8
Подок. камень К-8



Ok-39

Наличник К-27
Сандрик К-8
Вставка 60x160x160
Подок. камень К-8





КДМ

ФАСАДЫ ИЗ КАМНЯ

WWW.KDMASTERA.RU +7(495)704-60-38

Ok-40

Сандрик К-37
Наличник 20x160
Подок. камень К-37
Рамка 20x80xL
с фаской А



Ok-41

Наличник К-16
Подок. камень К-37
Рамка 20x80xL
с фаской А



Ok-42

База К-8
Капитель К-33
Рамка пилястры 80x80xL
Тело пилястры 60x250xL
Подоконный отлив ПДА
Подок. камень 60x80xL
Основание ОВ/2
Балясина ВЛ



Ok-43

Сандрик1
К-18 90x105xL
К-4 55x75xL
Плита
35x270xL
Сандрик2
К-18 90x105xL
Капитель пилястры
К-4
Тело пилястры
35x160xL
Подоконный камень
К-18 90x105xL
К-4 55x75xL
Пьедестал пилястры
35x160xL с фаской А
Вставка подоконная
с фаской А

